

TUV48S



toastmaster®

cookin' in style

UltraVection Oven®

INSTRUCTION MANUAL



INCLUDES RECIPES

READ AND SAVE THESE INSTRUCTIONS

WARNING: A risk of fire and electrical shock exists in all electrical appliances and may cause personal injury or death. Please follow all safety instructions.

IMPORTANT SAFEGUARDS

When using electrical appliances, basic safety precautions should always be followed to reduce the risk of fire, electric shock and injury to persons, including the following:

- Read all instructions before using appliance.
- Do not touch hot surfaces. Use handles and oven mitts.
- Do not immerse cord, plug, or appliance in water or other liquid. See cleaning instructions.
- This appliance is not for use by children.
- Close supervision is necessary when any appliance is used near children.
- **CAUTION:** Never leave appliance unattended when in use.
- Do not clean with metal scouring pads. Pieces of the pad may break off and touch electrical parts.
- Unplug from outlet when not in use and before cleaning. Press STOP button to turn appliance off before unplugging. Allow to cool before attaching or removing parts and before cleaning the appliance.
- Do not operate any damaged appliance. Do not operate with a damaged cord or plug, or after the appliance malfunctions or has been dropped or damaged in any manner. Return appliance to the nearest authorized service center for examination, repair, electrical or mechanical adjustment.
- When using this appliance, provide at least four inches of space above, behind, and on both sides for air circulation. Do not store any item on top of the appliance. Do not use on surfaces where heat may cause a problem.
- Oversized foods or utensils must not be inserted into the appliance.
- A fire may occur if this appliance touches or is covered by flammable material, including curtains, draperies, walls, etc., when in operation.
- Do not store any materials, other than manufacturer's recommended accessories, in this oven when not in use.
- Extreme caution should be exercised when using containers constructed of any material other than metal.
- Do not place any flammable material such as paper, cardboard, plastic, etc. in the oven.
- Do not cover drip tray or any part of the oven with metal foil. This will cause over-heating of the oven.
- Use attachments only if recommended by Toastmaster Inc.
- Do not use outdoors or while standing in a damp area.
- Do not let cord hang over edge of table or counter, or touch hot surfaces.

- Do not place on or near a hot gas or electric burner.
- Extreme caution must be used when moving an appliance containing hot oil or other hot liquids.
- Use extreme caution when removing bake/broil basket or drip tray or disposing of hot grease.
- Use appliance only as indicated in these instructions.

SAVE THESE INSTRUCTIONS

This product is for household use only.

CAUTION: A short power supply cord is provided to reduce the risk of personal injury resulting from becoming entangled in or tripping over a longer cord. Extension cords are available from local hardware stores and may be used if care is exercised in their use. If an extension cord is required, special care and caution is necessary. Also the cord must be: (1) marked with an electrical rating of 125 V, and at least 15 A., 1875 W., and (2) the cord must be arranged so that it will not drape over the countertop or tabletop where it can be pulled on by children or tripped over accidentally.

POLARIZED PLUG: This appliance has a polarized plug, (one blade is wider than the other). As a safety feature to reduce the risk of electrical shock, this plug is intended to fit in a polarized outlet only one way. If the plug does not fit fully in the outlet, reverse the plug. If it still does not fit, contact a qualified electrician. Do not attempt to modify the plug in any way.

ELECTRIC POWER: If electric circuit is overloaded with other appliances, your appliance may not operate properly. It should be operated on a separate electric circuit from other operating appliances.

PLASTICIZER WARNING

CAUTION: To prevent Plasticizers from migrating from the finish of the counter top or table top or other furniture, place **NON-PLASTIC** coasters or place mats between the appliance and the finish of the counter top or table top.

Failure to do so may cause the finish to darken, permanent blemishes may occur or stains can appear.

The UltraVection™ Oven is a patented technology that combines three methods of heat transfer (convection, conduction and radiant heat) which creates superheated air movement. The UltraVection™ Oven holds the flavor resulting in foods that are cooked with a superior taste, texture and appearance not possible with any other oven-cooking method. This revolutionary cooking process allows for greater moisture retention and is perfect for cooking fish, steaks, poultry, seafood, French fries and many convenience foods.

The UltraVection™ Oven may look like a typical oven. In fact, it is computer controlled and has a unique patented air surround basket. The UltraVection™ patented process cooks fast without microwaves, saving energy over a conventional oven . . . and most of all it's easy to use. It completely eliminates the use of oil, pans or trays. So enjoy those French fries and onion rings without the oil and the guilt!

Your product may vary slightly from illustrations.

Product Diagram/Explanation of control panel

UNIT

- A. UltraVection™ Oven
- B. Control Panel
- C. Feet
- D. Drip Tray (P/N 21265S)
- E. Drip Tray Slot (P/N 21266S)
- F. Patented Air Surround Basket
- G. Window
- H. Basket Handle

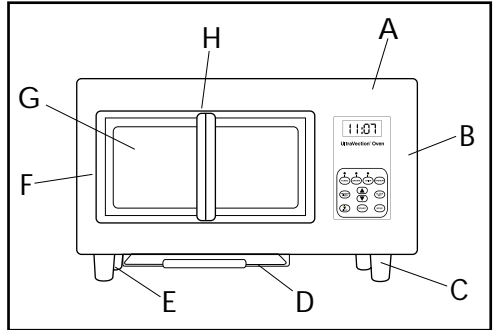

CONTROL PANEL DISPLAY

Indicates time of day or time remaining in the cooking function. Peel off the clear plastic film placed over the control panel.

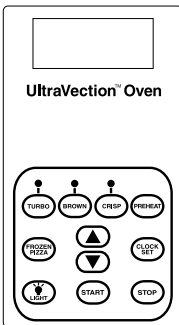

FUNCTION

ARROWS

Press arrows to adjust clock and time for TURBO, BROWN, and CRISP functions.

UP ARROW

Press once and time will increase in 10-second intervals. Press and hold and time will increase in 1-minute intervals.

DOWN ARROW

Press once and time will decrease in 10-second intervals. Press and hold and time will decrease in 1-minute intervals.

PREHEAT

Preset function is set at 4:00 minutes and can not be adjusted. Always preheat the UltraVection™ Oven for the first use except where indicated. When cooking consecutive batches of food it is not necessary to preheat after the first batch.

During PREHEAT, P will appear on the display.

TURBO is the basic cooking function. Food is rapidly seared, sealing in moisture and flavor. It is preset at 5:30 (5 minutes and 30 seconds) and can be adjusted from 10 seconds to 16 minutes. During use, the TURBO function light will be on. The cooking time will count down on the display.

CRISP is the finishing touch after cooking with TURBO. It adds a deep fried texture, color and crunch to French fries, tater tots, onion rings and many other foods. It is preset at :30 seconds and can be adjusted from 10 seconds to 6 minutes. During use, the CRISP function light will be on. The cooking time will count down on the display.

BROWN is the function for additional browning of the food. Preset function is :30 seconds and can be adjusted from 10 seconds to 5 minutes. During use, the BROWN function light will be on. The cooking time will count down on the display.

FROZEN PIZZA

This is a preset combination of TURBO, CRISP AND BROWN functions. It is a total of 8:00 minutes and can not be adjusted. Place frozen pizza into preheated oven, press the FROZEN PIZZA button and the oven will start automatically. The cooking time will count down on the display. Note: Since frozen pizza toppings vary, so do their cooking times. It is a good idea to check pizza for doneness one minute from end of the auto pizza cycle.

START

Press START to start the oven once the cooking function(s) has been selected: TURBO, CRISP and/or BROWN.

LIGHT

To turn the interior oven light on, simply push the LIGHT button. It will remain on for approximately five minutes before going off or may be turned off by pressing the LIGHT button again. To replace the bulb see Bulb Replacement.

STOP

Press and hold to stop operation of the oven. Press again to cancel a function.

CLOCK SET

Use this button to set time as described on page 6.

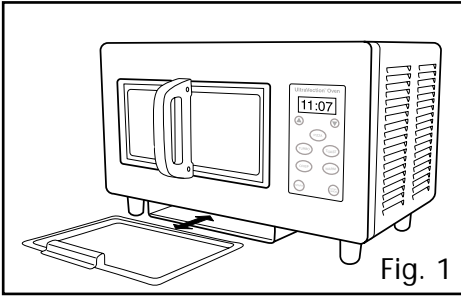

Fig. 1

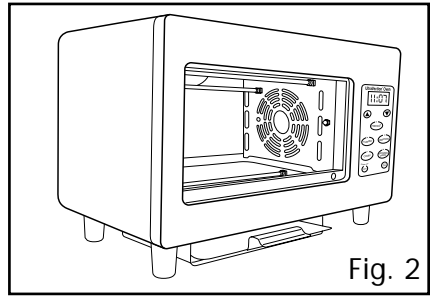

Fig. 2

BEFORE FIRST USE

1. Unwrap product and remove any packaging materials that may have been included to prevent damage during shipping.
2. Place on a flat, stable surface, approximately in the center (front to back) of counter-top..
3. Before using for the first time, the cooking basket and drip tray should be washed with warm soapy water. Rinse and dry.
4. Insert drip tray (Fig. 1). Always have drip tray in place before using (Fig. 2).
5. Read instruction book thoroughly to become familiar with the UltraVection™ Oven.

NOTE: A slight odor or smoking from the interior of the UltraVection™ Oven may be noticed when first using. This is normal due to residues from manufacturing.

SETTING THE CLOCK

1. Plug unit into 120V ~ 60Hz outlet. 12:00 will show on the display and the colon will blink.
2. Press the CLOCK SET button. The colon will stop blinking.
3. Press the UP ARROW or DOWN ARROW to select the time.
4. Press the START button, the colon will blink. The time will now be displayed and you will exit the clock setting mode.

NOTE: The instructions have been written with the clock set. However, the clock does not have to be set before using the oven. Just push function button(s), select cooking time(s), then START.

USING YOUR OVEN

The UltraVection™ Oven cooks using super heated air movement. Therefore, the outside of the oven and the glass door become hot. Always use caution when touching these parts and never use the top of your oven as a resting-place for anything. We recommend using a potholder or insulated mitt to remove the air surround basket after cooking. Foods become hot during the cooking process. Allow to cool slightly before serving.

Always preheat oven before using unless chart or recipe indicates otherwise.

1. Plug into 120V ~ 60Hz outlet. Set the clock.

2. Press the PREHEAT button, P will be on the display, the oven will start. After four minutes, the oven will beep and the P will flash on the display to indicate that it is preheated. The PREHEAT function is a preset function and can not be adjusted. If you do not start cooking within five minutes, PREHEAT again. The display will show the time of day after nine minutes if the oven is not used.

CAUTION: Use caution when removing basket and food. Protect your hands with insulated oven mitts. Always protect counter-top from heated basket when removing from unit.

3. Pull the handle of the air surround basket straight out. The TURBO default time shows on the display and the TURBO function light will be on. Add food to the non-stick grid. There should be space between food to allow air to circulate around the food. Insert food basket into oven.
4. Select one, two or all three functions, TURBO, CRISP, and/or BROWN in this order. Refer to cooking chart for times.
5. Press the START button, the function light will be on. During cooking, if the basket is removed and returned to oven in under nine minutes, the programmed cooking time will resume. Otherwise, the time of day will be displayed and the cooking time will need to be re-programmed.
Note: When a combination of functions is chosen, each function time will count down separately on the display window, one immediately following the other. While the time for each function is counting down, the light for that function will be on.
NOTE: The display will flash "OPEN" only when the basket is removed during the operation of a programmed function (PREHEAT, TURBO, BROWN or CRISP). The oven will resume operation when the basket is replaced in the oven. If a program function is selected and the oven beeps several times, the basket is not completely inserted in the oven.
6. The oven will beep and shut off automatically when the cooking cycle is complete. The last function light will be on and :0 will be on the display.
7. Carefully remove basket and food. Use a nylon or plastic utensil to remove food to protect non-stick coating. Never cut food in non-stick basket. When basket is removed, the display will read the time of day.

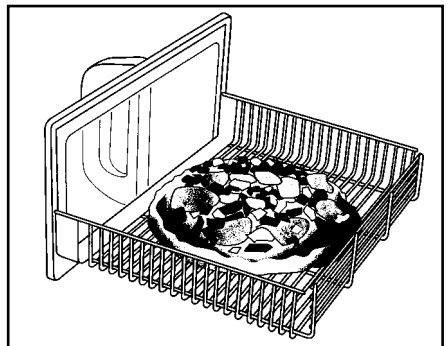
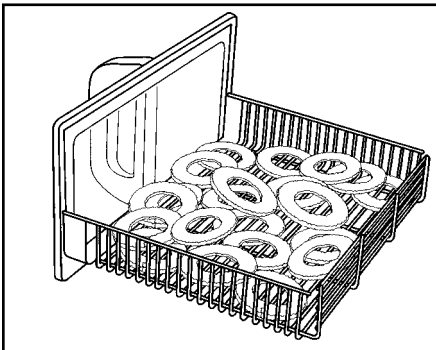

To prevent heat loss, avoid opening basket excessively. Start another basket of food immediately. If you wait more than five minutes, PREHEAT again before cooking.

8. Unplug and allow the oven and accessories to cool completely before cleaning. Keep drip tray and oven clean and free of crumbs, grease and particles. See CLEANING INSTRUCTIONS.

COOKING TIPS

- Times given in cooking charts are suggestions. Experimentation will be necessary to find the combination of cooking features that best suits your personal taste. For frozen convenience foods begin by starting with TURBO for approximately one half of package cooking time. Then add time for crisp and/or brown. If necessary, cook for additional time.
- Always watch foods closely when experimenting to prevent over- cooking. If food is not done when you take it out of the oven you can always return it to the oven for additional time.
- Arrange all food in a single layer in basket.
- For cooking small portions, make sure they are centered in the basket. When cooking large portions, distribute evenly to promote uniform cooking.
- Remove crumbs and/or ice crystals from food before placing in basket.
- Leave air space between foods to allow proper air circulation.
- Avoid cooking foods small enough to fall through basket.
- Do not cover food while it is cooking.
- When cooking more than one piece of meat, try to select even thicknesses. This will promote consistent doneness and appearance.
- Trim all excess fat off meat and poultry to reduce smoking and splattering.
- To toast two slices of bread, PREHEAT the oven. Center bread in the basket. Select BROWN for 40 seconds for light color toast, 50 seconds for medium and one minute for dark. At the end of the cycle, flip toast over and reprogram for the same time again.

CLEANING INSTRUCTIONS

CAUTION: DO NOT IMMERSE THE OVEN IN OR SPLASH WITH WATER OR OTHER LIQUID.

NOTE: Do not use harsh abrasives on any part of the oven.

1. Always unplug and allow to **cool** completely before cleaning or moving.
2. Remove basket. The glass window and wire basket may be disassembled for cleaning. Lay basket flat and pull the right side of the patented Air Surround Basket out and away from the glass door. Pull the other side away from the door. Clean and reassemble, keeping the door tabs (located on the glass door) on the inside of the patented Air Surround Basket.

3. Using a damp cloth and plastic scouring pad, wipe the inside of the oven cavity and heating elements removing any food residue or grease. Dry thoroughly.
4. Remove drip tray. Wash drip tray and patented Air Surround Basket in hot soapy water and dry thoroughly. The basket and tray may also be washed on the top rack of the dishwasher.
5. Reassemble making sure the top of wire basket fits securely into door tabs and hooks.
6. Slide drip tray back into the drip tray slot and replace the food basket.
7. Clean exterior with clean damp cloth and dry thoroughly after each use.

NOTE: Do not use without drip tray in place.

Any servicing requiring disassembly other than the above cleaning must be performed by an authorized service center.

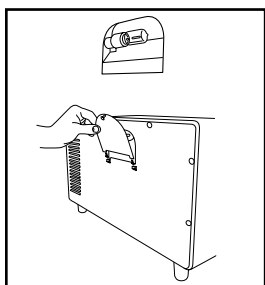

BULB REPLACEMENT

1. Unplug unit and allow oven to cool completely.
2. Remove the one screw securing the small cover plate in back of unit.
3. Remove bulb by turning.
4. Replace with new 15 watt bulb (P/N 2127OS).
5. Replace the cover and secure with screw.

Any service requiring disassembly, must be performed by a qualified electrician.

STORAGE

- Be sure the UltraVection™ Oven is completely cool before storing.
- All parts should be thoroughly cleaned and dried.
- Always store with basket in place.

CONVENIENCE FOOD COOKING CHART

Times below are in a preheated oven and to be used only as a guideline. If using a different brand of food or quantity of food, times may need to be adjusted to personal taste. When cooking other brands and flavors of pizza, you may need to experiment to find the best combination of functions instead of using the FROZEN PIZZA button.

FOOD	AMOUNT	TURBO CRISP	BROWN		
APPETIZERS - SNACKS					
TGI Friday's™ Potato Skins	8 oz.	8 min. 30 sec.			
Breaded Mushroom Poppers®	8 oz.	7 min.			
Stuffed Jalapenō Poppers®	16 oz.	6 min.			30 sec.
Cheese Sticks Poppers®	8 oz.	5 min.	1 min.		
LaChoy® Egg Rolls	7.25 oz.	4 min.	1min. 30 sec.		
Tyson® Hot'n Spicy Chicken Wings	14 oz.	9 min.	1 min.		
Delimex® Chicken Taquitos	10 Taquitos	4 min. 30 sec.			
Pillsbury® Toaster Struddle	2-4		3 min.		1 min.
Pillsbury® Toaster Scramble	2-4		3 min.		1 min.
SuperPretzel® Frozen Baked Soft Pretzels	3 pretzels	2 min.	1 min.		
NY™ Texas Garlic Toast	4 slices	3 min.	2 min.		
FRENCH FRIES - ONION RINGS					
Ore Ida® Golden Crinkles	2 servings	5 min.	1 min.		
Ore Ida® Golden Crinkles	3 servings	7 min.	1 min.		
Ore Ida® Golden Crinkles	4 servings	9 min.	1 min.		
Ore Ida® Steak Fries	2 servings	6 min.	1 min.		
Ore Ida® Steak Fries	4 servings	8 min.	1 min.		
Ore Ida® Tater Tots	4 servings	6 min.	3 min.		1 min.
Ore Ida® Onion Rings	4 servings	7 min.	1 min.		
PIZZA					
Freschetta™ 4-Cheese Pizza	11.15 oz.	Press pre-programmed FROZEN PIZZA button.			
Freschetta™ Pepperoni Pizza	11.58 oz.	Press pre-programmed FROZEN PIZZA button.			
DiGiorno® Four Cheese Rising Crust Pizza	12 oz.	Press pre-programmed FROZEN PIZZA button.			
Jenos® Crisp' n Tasty	7 oz.	5 min.			
Totino's® Crisp'n Crust Party Pizza	10.9 oz.	6 min.			
Ore Ida® Bagel Bites	7 oz.	5 min.			
Totino's® Pizza Rolls	15 oz.	5 min.	1 min.		
ENTREES					
Holten Meats Thick N Juicy® Quarter Pound Beef Patties	4 patties	14 min.			
Banquet® Chicken Nuggets	13.5 oz.	5 min.	30 sec.		
Mrs. Paul's Select Cuts™ Fish Sticks	18 sticks	6 min. 30 sec.			
Mrs. Paul's Select Cuts™ Fish Filets	8 filets	9 min.			
Sea Pak® Breaded Popcorn Shrimp	6 oz.	4 min.	1 min.		
Sea Pak® Breaded Butterfly Shrimp	9 oz.	6 min.			
Kroger® Breaded Calamari Rings	6 oz.	3 min.	1 min.		

MEAT, POULTRY AND SEAFOOD COOKING CHART

PREHEAT OVEN EXCEPT FOR FROZEN MEATS

One of the UltraVection's™ Oven most convenient features is its ability to cook frozen steaks, chops and fillets to restaurant quality perfection in very little time. To grill frozen meats, DO NOT PREHEAT the oven. Place food in the basket and put in the UltraVection oven. Press PREHEAT and at the end of the preheat time, cook on TURBO and/or CRISP for the time in the cooking chart. If meat is undercooked when removed from the oven, return to the oven for additional cooking time. If another batch of frozen meat is needed, carefully place into the hot oven and cook for a few minutes less than the time in the frozen meat chart. The second batch will be more browned on the outside when the inside achieves the same doneness.

Cooking Chart Information

The times listed in the cooking chart are to be used ONLY AS A GUIDE-LINE. Use a meat thermometer to be sure of internal temperature for food safety. Cooking times will vary with thickness of meat. We do not recommend cooking frozen poultry or seafood.

NOTE: The USDA recommends that foods should be cooked to a minimum internal temperature as listed below:

Beef, pork, lamb, ground products	160°F
Beef, pork, lamb, roasts or steaks	145°F
Poultry products	170-180°F
Ground poultry products	165°F
Seafood	145-150°F

FOOD	AMOUNT	COOK TO	TURBO	CRISP	BROWN
BEEF - Fresh					
T-bone Steak	2 8 oz. ½-inch thick	145°F Med. Rare 160°F Medium 170°F Well	7 min. 30 sec. 9 min. 11 min.		
T-bone Steak	1 8 oz. ½-inch thick	145°F Med. Rare 160°F Medium 170°F Well	5 min. 30 sec. 6 min. 30 sec. 8 min.		
Rib Eye Steak	4 8 oz. 1-inch thick	145°F Med. Rare 160°F Medium 170°F Well	15 min. 15 min. 15 min.	2 min. 30 sec. 5 min. 5 min.	3min. 30 sec.
Rib Eye Steak	2 8 oz. 1-inch thick	145°F Med. Rare 160°F Medium 170°F Well	15 min. 15 min. 15 min.	1 min. 3 min. 5 min.	
Hamburgers	4 4 oz. ½-inch thick	160°F Well	9 min. 30 sec.		
Frozen - Place food in cold basket then preheat and follow times.					
T-bone Steak	2 8 oz. ½-inch thick	145°F Med. Rare 160°F Medium 170°F Well	8 min. 10 min. 14 min. 30 sec.		
T-bone Steak	1 8 oz. ½-inch thick	145°F Med. Rare 160°F Medium 170°F Well	7 min. 30 sec. 9 min. 30 sec. 11 min. 30 sec.	2 min.	
Hamburgers	4 4 oz. each ½-inch thick	160°F Well	14 min.		

MEAT, POULTRY AND SEAFOOD COOKING CHART (Con't.)

FOOD	AMOUNT	COOK TO	TURBO	CRISP	BROWN
POULTRY - Fresh					
Chicken Wings	8 wings	180°F Well	14 min.	3 min.	30 sec.
Chicken Breast Tenders	1 lb.	170°F Well	9 min. 30 sec.		
Chicken Breast Boneless Skinless*	2 4 oz.	170°F Well	12 min.		
Chicken Legs	6 legs	180°F Well	12 min.	5 min.	
Turkey Burgers	4 4 oz. ½-inch thick	165°F Well	12 min.		
PORK - Fresh					
Pork Loin Chops	2 8 oz. ½-inch thick	160°F Medium 170°F Well	8 min. 30 sec. 12 min. 30 sec.		
Pork Loin Chops	3 8 oz. ½-inch thick	160°F Medium 170°F Well	9 min. 30 sec. 13 min. 30 sec.		
American Pork Chops	2 8 oz. 1-inch thick	160°F Medium 170°F Well	15 min. 16 min.		
American Pork Chops	4 6 oz. 1-inch thick	160°F Medium 170°F Well	16 min. 16 min.	4 min. 5 min.	
PORK - Frozen - Place food in cold basket then preheat and follow times.					
Pork Loin Chops	2 8 oz. ½-inch thick	160°F Medium 170°F Well	10 min. 14 min.		
SEAFOOD - Fresh					
Salmon Fillets	2 8 oz. ¾-inch thick	145°F	11 min.		
Salmon Steak	1 4 oz. ½-inch thick	145°F	5 min.		30 sec.
Sea Scallops	1 lb.	145°F	5 min.		
Jumbo Shrimp	1 lb.	145°F	5 min. 30 sec.		
Orange Roughy	2 6 oz. ½-inch thick	145°F	9 min.		
MISCELLANEOUS - Fresh					
Rodeo® Hot Dogs	10 hot dogs	165°F		3 min.	30 sec.
Armour™ Jumbo Hot Dogs	8 hot dogs	165°F		4 min.	1 min. 20 sec.
Bob Evans® Original Breakfast Sausage Links	14 links	165°F	6 min. 30 sec.		
Fresh Sausage Patties	9 slices	165°F	6 min.	2 min.	1 min.
Johnsonville® Bratwurst	5 Bratwurst	165°F	10 min.		

*Marinating before cooking is recommended.

Some of the recipes in this book are from the following organizations: National Pork Producers Council, The National Honey Board, Belgian Endive Marketing Board, New Zealand Wasubi Limited, and Lawrys.

MARINADES

Marinades usually consist of liquid ingredients such as fruit or vegetable juices, wine, water and oil in combination with seasonings and herbs. Meat and poultry is allowed to soak in the marinade mixture for several hours or as long as overnight to impart flavor and/or tenderize. To tenderize, a marinade must contain an acidic ingredient such as lemon juice, wine, vinegar or yogurt; the acid penetrates meat fibers to help tenderize them.

Guidelines for Marinating

- Always marinate food in refrigerator; never at room temperature.
- Allow $\frac{1}{4}$ to $\frac{1}{2}$ cup of marinade for each 1 to 2 pounds of meat.
- Cooked marinades should be completely cooled before adding to food.
- The tenderizing effect of a marinade is usually about $\frac{1}{4}$ -inch from the cut surface of the meat.
- A heavy-duty sealable plastic bag is convenient for marinating; a glass dish may also be used. Select dishes in which the foods will fit snugly but lie flat.
- Turn food occasionally during marinating so that all sides are equally exposed to the marinade.
- For tenderization to take place, beef must be marinated at least 6 hours or as long as overnight. Marinating longer than 24 hours causes the meat fibers on the surface to break down, resulting in a “mushy” texture.
- Remaining marinade may also be served as a sauce with the grilled meat or poultry. It should be heated to the boiling point before serving.
- If marinade is not used as a sauce for the meat or poultry, it should be discarded.

Blend all ingredients together. Toss, coating meat completely. Marinate in refrigerator at least 30 minutes. Pat dry before grilling.

RED WINE VINEGAR

- ¼ cup red wine vinegar
- 2 TBL vegetable oil
- 1 TBL Dijon® mustard
- 1 clove minced garlic
- ½ tsp dried Italian seasoning
- ⅛ tsp coarsely ground pepper

SZUECHAUN

- ⅛ cup soy sauce
- 3 TBL lemon juice
- 1 TBL sesame oil
- 2 TBL sugar
- 2 TBL corn starch

CURRY YOGURT

- ⅓ cup plain yogurt
- 2 TBL lemon juice
- 1 TBL vegetable oil
- 2 cloves minced garlic
- ½ tsp curry powder
- ⅛ tsp crushed red pepper

SPICY HERB

- ½ cup vinegar
- ½ cup vegetable oil
- 2 TBL lemon juice
- ½ tsp Tabasco® pepper sauce
- ¼ cup chopped onions
- 1 clove minced garlic
- ¼ tsp salt
- ¼ tsp dried basil leaves
- ⅛ tsp dried tarragon leaves
- ⅛ tsp dry mustard

MEXICALI

- ½ cup prepared salsa
- 2 TBL lime juice
- 1 TBL vegetable oil
- 2 TBL chopped cilantro

LEMON ORIENTAL

½ cup lemon juice
1 TBL soy sauce
1 TBL vegetable oil
2 TBL chopped onion
¼ tsp ground ginger
⅛ tsp crushed red pepper

FIVE-SPICE

¼ cup soy sauce
¼ cup lemon juice
½ cup minced onion
2 TBL grated fresh ginger root
2 tsp five-spice powder
2 TBL chili oil
2 tsp sesame oil

HONEY GARLIC

½ cup lemon juice
¼ cup honey
2 TBL soy sauce
2 cloves crushed garlic

ISLAND

½ cup orange juice
4 TBL lime juice
3 cloves crushed garlic
2 tsp dried thyme
1 TBL honey

HERBED

⅓ cup each red wine vinegar and water
1 TBL vegetable oil
1 tsp dried thyme leaves or 1 TBL minced fresh thyme leaves
½ tsp each coarsely ground black pepper, salt and sugar

ZESTY

1½ TBL each dry mustard and sweet paprika
1 TBL ground coriander
1 tsp coarsely ground black pepper
½ tsp salt
3 TBL lemon juice
2 TBL each vegetable oil and water
3 cloves minced garlic

LEMON-BASIL

- ¼ cup *each* fresh lemon juice and water
- 1 TBL finely chopped fresh basil *or* 1 tsp dried crushed basil leaves
- 1 tsp vegetable oil
- ½ tsp grated lemon peel
- ¼ tsp coarsely ground black pepper

RUBS

Rubs are a highly concentrated blend of herbs and spices which flavors the exterior of the food as it cooks. They are applied to the exterior surface of tender cuts of meats and poultry just before cooking; they need no standing time. However, for convenience, rubs may be applied several hours in advance. The coated meat should be refrigerated until cooking time. Flavors become more pronounced the longer the rub is on the meat. You can create your own blend of seasonings for rubs or use a commercial blend.

CAJUN SEASONING

- 1 TBL dried basil leaves
- 1 TBL dried oregano leaves
- 1 TBL paprika
- 2 tsp salt
- 2 tsp dried thyme leaves
- 1 tsp ground allspice
- ½ tsp ground red pepper

SOUTHWESTERN

- 1½ tsp chili powder
- 1 tsp garlic powder
- ½ tsp dried crushed oregano
- ½ tsp ground cumin

LEMON-ROSEMARY

- 1½ tsp grated lemon peel
- 1 tsp dried rosemary leaves
- ¼ tsp salt
- ¼ tsp thyme leaves
- ¼ tsp coarsely ground pepper
- 2 cloves minced garlic

MEDITERRANEAN

- Zest of 2 lemons
- ⅓ cup thinly sliced garlic cloves
- ⅓ cup fresh chopped rosemary
- ¼ cup fresh chopped sage leaves
- ¼ cup coarsely ground black pepper
- 2 TBL salt

CARIBBEAN JERK

2 TBL dehydrated onion
1 TBL garlic powder
4 tsp dried crushed thyme leaves
2 tsp salt
2 tsp ground allspice
½ tsp ground nutmeg
1 TBL sugar

CAJUN

2 TBL paprika
2 tsp salt
2 tsp onion powder
2 tsp garlic powder
2 tsp cayenne pepper
1½ tsp ground white pepper
½ tsp ground black pepper
1 tsp dry thyme leaves
1 tsp oregano leaves

SPICY FIREWORKS

2 TBL ground cumin
2 TBL chili powder
1 TBL ground coriander
1½ tsp cayenne pepper
1 TBL ground black pepper
1½ tsp ground cinnamon
1½ tsp brown sugar
¾ tsp salt

QUICK SERVE DIPPING SAUCES

Blend ingredients together and serve.

CHINESE MUSTARD

Yield: ¾ cup

4 tsp dry mustard
6 TBL soy sauce
4 TBL cider vinegar
2 tsp sesame oil
1 tsp sugar
Water to taste

ITALIAN BARBECUE

Yield: ½ cup

½ cup barbecue sauce
2 TBL Italian salad dressing

HONEY MUSTARD

Yield: ¾ cup

½ cup honey
¼ cup Dijon® mustard

CHILLED DIPPING SAUCES

Blend ingredients together, chill and serve.

GUACAMOLE

Yield: 1 cup

2 ripe avocados, mashed
Juice of one lemon
½ small red onion, diced
1 tomato, seeded and diced
Salt to taste
Hot pepper sauce, to taste

CREAMY HONEY SESAME

Yield: 1½ cups

¾ cup mayonnaise
¼ cup rice vinegar
¼ cup honey
3 TBL toasted sesame seeds
1 TBL grated fresh ginger root
1 small clove minced garlic
¾ tsp Oriental sesame oil
⅛ tsp crushed red pepper flakes
Salt, to taste

SWEETLY CURRIED

Yield: 2 cups

1 cup sour cream
6 TBL honey
2 TBL cider vinegar
2 tsp curry powder
½ tsp ground cumin
¼ tsp salt
2 TBL chopped fresh cilantro
OR
2 TBL chopped fresh parsley

BLUE CHEESE

Yield: 1½ cups

½ pint sour cream
¼ cup milk
⅓ cup blue cheese, crumbled
2 TBL finely diced red onion

SPICY DIPPING SAUCE

Yield: ¾ cup

4 TBL soy sauce
4 TBL rice vinegar
2 TBL water
1 TBL molasses
1 tsp crushed red pepper
1 clove minced garlic

WARM SERVE DIPPING SAUCES

Follow instructions below each recipe and serve.

SASSY SEAFOOD

Yield: 1¼ cups

1 cup catsup
3 TBL lemon juice
1 TBL sugar
2 tsp prepared horseradish
½ tsp Tabasco® pepper sauce

Place all ingredients into sauce pan and heat on stovetop over medium heat until hot, stirring occasionally.

SALMON

Yield: 2½ cups

3 TBL butter
1 clove minced garlic
½ cup chopped onion
3 TBL flour
1½ cups milk
¼ tsp thyme
2 TBL tomato paste
2 TBL lemon juice

Place butter in sauce pan and heat on stovetop over medium heat until butter melts. Saute onion and garlic.

Blend in flour, milk and remaining ingredients. Cook until mixture bubbles and thickens, stirring occasionally.

DILL

Yield: 1½ cups

3 TBL butter
3 TBL flour
1½ cups milk
2 TBL fresh minced dill
pinch nutmeg

Place butter in sauce pan and heat on stovetop over medium heat until butter melts.

Blend in flour, milk and remaining ingredients. Cook until mixture bubbles and thickens, stirring occasionally.

SPECIALTY DIPPING SAUCES

Follow instructions below each recipe and serve.

HOT CLAM AND CRAB

Yield: 3¼ cups

8 oz cream cheese, softened
¼ cup butter, do not substitute margarine
¼ cup mayonnaise
6½ oz canned crabmeat, drained
6½ oz canned clams, drained

Combine all ingredients in saucepan, heat slowly, stirring occasionally for about 30 minutes until warmed thoroughly.

SPICED

Yield: $\frac{1}{3}$ cup

1 small clove crushed garlic
 $\frac{1}{2}$ tsp toasted cumin seed
 $\frac{1}{2}$ tsp paprika
1 pinch cayenne pepper
 $\frac{1}{4}$ cup olive oil
1 TBL balsamic vinegar
2 TBL water

Place crushed garlic and spices in a grinder and blend to form a smooth paste. Put in a bowl, and very gradually whisk in the oil and then vinegar followed by water to form a thin pouring sauce.

GRILLED SALSA-CHEESE

Yield: $1\frac{1}{3}$ cups

$\frac{1}{2}$ pound mild cheese (such as Edam, Gouda or Jack)
 $\frac{1}{2}$ cup bottled salsa

Shred cheese; place in small sauce pan. Stir in salsa. Heat on stovetop over medium heat until cheese melts, stirring frequently to make sure cheese doesn't scorch.

RECIPES

Cooking times are for thawed meats.

SUNNY SIRLOIN STEAK

Yield: 4 servings

1 lb beef top sirloin steak, $\frac{3}{4}$ -inch thick, cut in 4 pieces
 $\frac{1}{2}$ cup orange juice
 $\frac{1}{4}$ cup soy sauce
1 clove minced garlic
2 dashes ground cloves

Combine orange juice, soy sauce, garlic and cloves. Place steak in a large sealable plastic bag, add marinade, turning once to coat. Seal bag securely and marinate in refrigerator 2 to 4 hours, turning at least once. Drain marinade from steak. Arrange in single layer in basket. Cook on TURBO 13 minutes or until done.

CARIBBEAN CHICKEN WINGS

Yield: 8 wings

$\frac{1}{3}$ cup rice wine vinegar
 $\frac{1}{3}$ cup pineapple juice
 $\frac{1}{2}$ tsp garlic salt
 $\frac{1}{2}$ tsp hot pepper sauce
8 chicken wings

Combine vinegar, pineapple juice and seasonings. Place chicken wings in a large sealable plastic bag, add marinade turning once to coat. Seal bag and marinate in refrigerator 2 to 4 hours turning at least once. Drain marinade from chicken wings. Arrange in single layer in basket. Cook on TURBO 5 $\frac{1}{2}$ minutes, CRISP 6 minutes and BROWN 1 minute or until done.

MARIACHI CHICKEN BITES

Yield: 4 servings

$\frac{3}{4}$ cup crushed tortilla chips
1 $\frac{1}{2}$ oz package Lawry's® Taco Spices and Seasonings
1 lb chicken breast tenders, cut in 1-inch cubes

In large sealable plastic bag, combine chips and taco spices and seasoning; shake. Dampen chicken with water, shake off excess. Put chicken in bag and shake to coat with chips. Arrange in single layer in basket. Cook on TURBO 5 minutes, and CRISP 3 minutes or until done.

HONEY MUSTARD-GLAZED STEAKS

Yield: 2 servings

1 $\frac{1}{2}$ TBL coarse-grain or regular Dijon®-style mustard
 $\frac{1}{2}$ tsp chopped parsley
2 tsp honey
 $\frac{1}{2}$ tsp each cider vinegar and water
 $\frac{1}{8}$ tsp hot red pepper sauce
 $\frac{1}{8}$ tsp coarse ground black pepper
2 8-oz beef top sirloin steaks, $\frac{3}{4}$ -inch thick
2 onion slices, $\frac{1}{4}$ -inch thick

Combine mustard, parsley, honey, vinegar, water, pepper sauce and pepper. Place beef top loin steaks in basket; brush top with $\frac{1}{2}$ tablespoon glaze. Place onion slices on top of glazed steak. Top with remaining sauce. Cook on TURBO 15 minutes or until done.

MINI MARYLAND CRAB CAKES

Yield: 12 servings

2 slices bread, crusts removed and cubed
2 6-oz cans Fancy Lump crab meat, drained
1 egg, beaten
½ tsp seafood seasoning (like Old Bay®)
1 tsp baking powder
1 tsp parsley
1 tsp Worcestershire sauce
1 TBL mayonnaise
1 tsp Dijon® mustard

Combine ingredients. Shape into 12 patties. Arrange in single layer in basket. Cook on CRISP 3 minutes and BROWN 2 minutes or until done.

FLAVORFUL TURKEY BURGERS

Yield: 4 servings

1 cup cooked brown rice
½ cup chopped onion
1 small apple, peeled and chopped
1 clove minced garlic
½ tsp dried sage
¾ lb ground turkey
2 TBL ketchup
½ tsp salt
⅛ tsp ground black pepper
4 hamburger buns

Cook rice and set aside to cool.

Combine ingredients in large bowl. Shape into 4 ¾-inch thick patties. Arrange in single layer in basket. Cook on TURBO 16 minutes and CRISP 3 minutes or until done. When burgers are done, open basket and place tops of buns on burgers followed by the bottoms. Cook on TURBO for 1 minute to warm buns.

TERIYAKI PORK CHOPS

Yield: 2 servings

2 ½-inch thick pork loin chops
¼ cup teriyaki marinade
1 tsp hot pepper sauce
1 TBL chopped green onion

Combine all ingredients in a bowl or a large sealable plastic bag and marinate from 30 minutes to overnight in the refrigerator. Remove chops, discarding marinade. Arrange in single layer in basket. Cook on TURBO 8½ minutes or until done.

CORIANDER-PEPPER CHOPS

Yield: 2 servings

- 2 ½-inch pork loin chops
- 1 clove crushed garlic
- ½ TBL ground coriander
- ½ TBL coarsely ground black pepper
- ½ TBL brown sugar
- 1½ TBL soy sauce

Combine all ingredients in a large sealable plastic bag and marinate for 30 minutes. Remove chops from marinade, discarding marinade. Arrange in single layer in basket. Cook on TURBO 11½ minutes or until done.

FAJITAS

FAJITA MARINADE

- ¼ cup olive oil
- 1 TBL white wine vinegar
- ½ tsp Tabasco® pepper sauce
- 1 TBL lemon juice
- ½ tsp chili powder
- ½ tsp salt
- ⅛ tsp garlic salt

FAJITA MIXTURE

Yield: 2 Servings

- ½ lb chicken breast tenders, cut in half lengthwise
- ½ red pepper, sliced in ½-inch rings
- ½ green pepper, sliced in ½ inch rings
- ½ medium onion, sliced in ½-inch rings
- 4 flour tortillas

Prepare marinade in large sealable plastic bag. Add meat and vegetables. Marinate for 30 minutes or overnight in refrigerator. Place vegetables and meat in single layer in basket. Cook on TURBO 7½ minutes and BROWN 2 minutes or until done. Remove meat and vegetables mixture. Place tortillas, one at a time into basket and warm on BROWN for 30 seconds each. Serve with your favorite condiments: salsa, sour cream, shredded cheese, avocado, or refried beans.

PILLSBURY® CINNAMON ROLLS

Yield: 8 rolls

- 12.4 oz tube Pillsbury® Cinnamon Rolls
- 1 handi-foil® brownie pan (9 ⅝-inches x 6 ⅞-inches x 1 ¼-inches) non-stick spray

DO NOT PREHEAT THE OVEN. Place the rolls, cinnamon topping up, in greased disposable lightweight foil pan. Place foil pan in basket and insert into COLD oven. Press PREHEAT. When preheat cycle is over, IMMEDIATELY cook on TURBO 2 minutes 10 seconds and CRISP 2 minutes or until done. Remove and allow to cool slightly before icing.

PILLSBURY® REAL APPLE TURNOVERS

Yield: 6 turnovers

12 oz box refrigerated Pillsbury® Real Apple Turnovers
1 handi-foil® brownie pan (9 ⁵/₁₆-inches x 6 ⁷/₈-inches x 1 ¹/₄-inches)
non-stick spray

DO NOT PREHEAT THE OVEN. Fill three turnovers according to package directions. Place in greased lightweight foil pan. Place foil pan in basket and insert into COLD oven. Press PREHEAT. When preheat cycle is over, IMMEDIATELY cook on TURBO 2 minutes 10 seconds and CRISP 1 minute 30 seconds. Allow to cool and repeat for remaining turnovers.

PILLSBURY® BUTTERMILK BISCUITS

Yield: 10 biscuits

7.5 oz can Pillsbury® buttermilk biscuits
1 handi-foil® brownie pan (9 ⁵/₁₆-inches x 6 ⁷/₈-inches x 1 ¹/₄-inches)
non-stick spray

DO NOT PREHEAT THE OVEN. Place biscuits into greased disposable lightweight foil pan. Place foil pan in basket and insert into COLD oven. Press PREHEAT. When preheat cycle is over, IMMEDIATELY cook on TURBO 2 minutes 20 seconds and CRISP 1 minute.

PILLSBURY® CRESCENT ROLLS

Yield: 4 rolls

4 oz tube Pillsbury® Original Crescent Dinner Rolls
1 handi-foil® brownie pan (9 ⁵/₁₆-inches x 6 ⁷/₈-inches x 1 ¹/₄-inches)
non-stick spray

DO NOT PREHEAT THE OVEN. Place the rolls in greased disposable lightweight foil pan. Place foil pan in basket and insert into COLD oven. Press PREHEAT. When preheat cycle is over, IMMEDIATELY cook on TURBO 2 minutes 20 seconds and CRISP 1 minute.

SERVICE INFORMATION

Please refer to warranty statement to determine if in-warranty service applies. This appliance must be serviced by a Toastmaster authorized service center. Unauthorized service will void warranty. Consult your phone directory under "Appliances-Household-Small-Service and Repair," or call 1-800-947-3744 in the U.S. and Canada, 52-5-397-2848 in Mexico.

If an authorized service center is not available locally, your appliance may be returned postage prepaid to our National Service Center at the address shown on the back of this book.

Products must be adequately protected to avoid shipping damage. Surround your appliance with three inches of protective padding and include a copy of your dated sales receipt and a note explaining the problem you have experienced. We recommend insuring your package. No CODs accepted.

FOOD	AMOUNT	TURBO	CRISP	BROWN

FOOD	AMOUNT	TURBO	CRISP	BROWN

LIMITED ONE-YEAR GUARANTEE

Toastmaster Inc. warrants this product, to original purchaser, for one year from purchase date to be free of defects in material and workmanship.

This warranty is the only written or express warranty given by Toastmaster Inc. This warranty gives you specific legal rights. You may have other rights which vary from state to state. ANY OTHER RIGHT WHICH YOU MAY HAVE, INCLUDING ANY IMPLIED WARRANTY OF MERCHANTABILITY OR FITNESS FOR A PARTICULAR PURPOSE IS LIMITED IN DURATION TO THE DURATION OF THIS WARRANTY.

Defective product may be brought or sent (freight prepaid) to an authorized service center listed in the phone book, or to Service Department, Toastmaster Inc., 708 South Missouri St., Macon, MO 63552, for free repair or replacement at our option.

Your remedy does not include: cost of inconvenience, damage due to product failure, transportation damages, misuse, abuse, accident or the like, or commercial use. IN NO EVENT SHALL TOASTMASTER INC. BE LIABLE FOR INCIDENTAL OR CONSEQUENTIAL DAMAGES.

Some states do not allow limitations on how long an implied warranty lasts, or allow the exclusion or limitation of incidental or consequential damages, so the above limitations or exclusions may not apply to you.

For information, write Consumer Claims Manager, at the Macon address. Send name, address, zip, telephone area code and daytime number, model, serial number, and purchase date.

KEEP DATED SALES RECEIPT FOR WARRANTY SERVICE.

Keep this booklet. Record the following for reference:

Date purchased _____

Model number _____

Date code (stamped on bottom) _____

EVERYBODY EATS. It's a fact of life.

**But sometimes preparing
meals can become a chore.**

**That's why TOASTMASTER has been invited
into millions of kitchens just like yours
so we can HELP YOU MASTER your
mixing, baking, grilling, toasting,
brewing, heating and serving
tasks WITH EASE AND STYLE.**

**The TOASTMASTER name stands for a
CELEBRATION of INNOVATION designed
to serve your life and keep you
COOKIN' IN STYLE.**



toastmaster®

?? QUESTIONS??

Before Contacting Your Retailer,

**Call TOLL-FREE
1-800-947-3744**

**Monday - Friday,
7:30 a.m. - 5:30 p.m. C.S.T.**



*FLAVORFUL, JUICY STEAKS - from frozen to
grilled perfection at ULTRAVECTION speed*



*CRISP, HOT PIZZA IN 8 MINUTES!
No soggy crust!*



*FRIES COME OUT SO HOT AND CRISPY -
you'll think they're deep-fried!
No need to add any oils!*